

TECHNICAL BULLETIN

Model : Q05-2,3,4 Smoke and Heat Detector Specification :

- Operating Voltage : 24V DC
- Supervisory Current : 70 μ A
- Alarm Current : 30mA @24V DC
- Thermal Setting : 58°C
- Ambient Temperature : -10°C ~ +55°C

MAINTENANCE :

- Attach dust-cover to the detector during the work in the building to prevent the invasion of dust or paint and malfunction of detector.
- During the scheduled maintenance, use the testing device to check the detector whether or not it is in good shape. (Use the SMOKE TESTER spread to the detector, it should alarm within 5 seconds. If not, return the detector to factory for service.)
- When the repair is needed please return the defect device to manufacturer.

SERVICING TESTS :

- Check two sides of iron-plate under the detector head whether or not they are well conducted.
If fault alarm happened regularly, check the environment for effective factors such as smoke or other heat sources.
- Malfunctioned circuit could not be fixed if it is caused by water leaking.
- If detector has no response all the time, it might be the burning of PCB, low sensitivity or decay of detector. Defective detector should sent back to the manufacturer for repairing and calibration.
- If the identification lamp does not lit while detector is operating, the LED or PCB might be burned and both of them need to be fixed in the factory.

INSTALLATION INSTRUCTIONS

Issue/Document Number: 090202

AVOID THESE LOCATIONS

Do Not Locate Your Detector in :

- Front of forced air ducts used for heating and air conditioning and other higher air flow area.
- Height of installation surface is more than 20 meters.
- Dusty area.
- Areas where temperature may fall below 40°F or rise above 100°F.
- Near electrical lights. "WARNING" - Connect Detector Only To Control Unit Initiating Device Circuit As Specified In Detector Or Control Unit Literature Or System May Not Operate.

Wiring Diagram

2-Wire Type

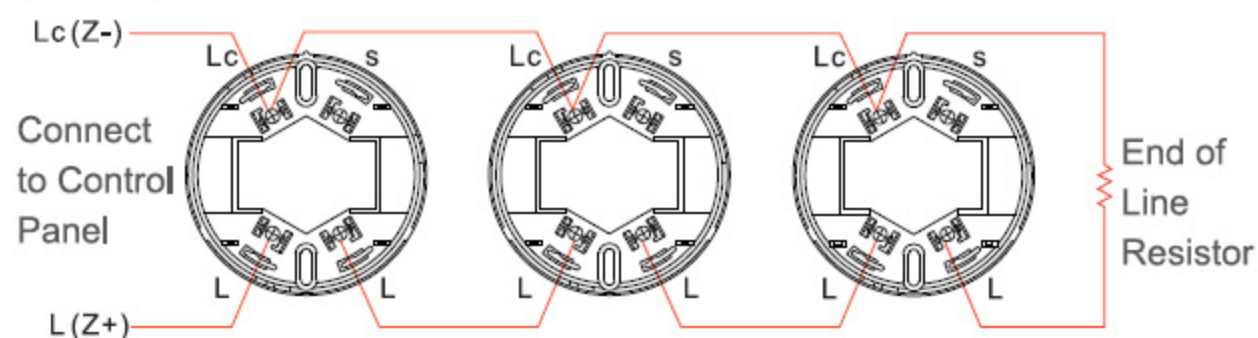

3-Wire Type

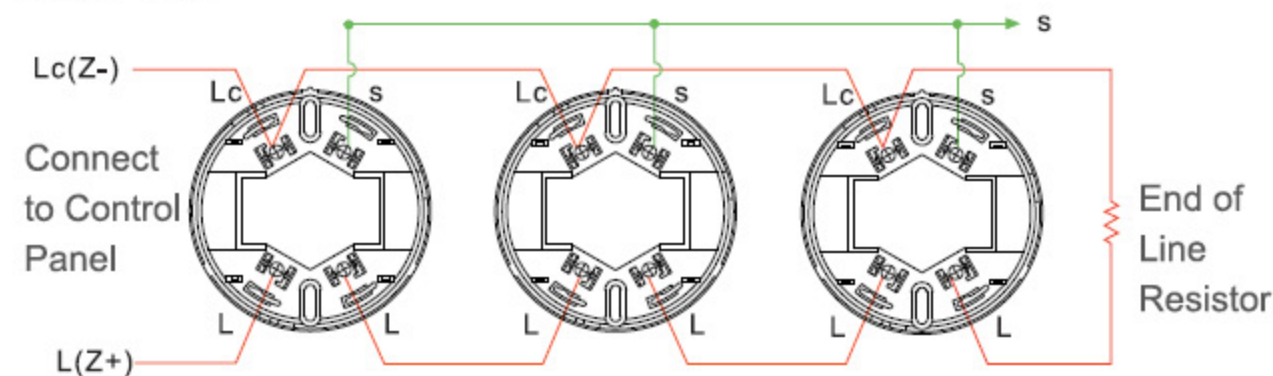

4-Wire Type

